



Translation of  
**Validation Report**  
**QB 103/2010**

*Original report in German established by*



**DOMETIC MT4-ET+4**  
**DOMETIC MT4-ET+22**  
**DOMETIC MT4-ET+37**  
**DOMETIC MT4-ET-32**



## Index of Contents

<b>Page</b>	<b>Content</b>
4 .....	Introduction
6 .....	Acceptance criteria
7 .....	Measuring methodology
8 .....	Summary of results
10 .....	Measurement results

## Introduction

This sample validation serves as proof of the effectiveness of the DOMETIC MT4-ETx series transport containers for the transport of blood preparations and samples with the use of eutectic thermal energy storage elements.

In their design for use with eutectic thermal storage elements, the MT4 transport container is individually configurable for different products:



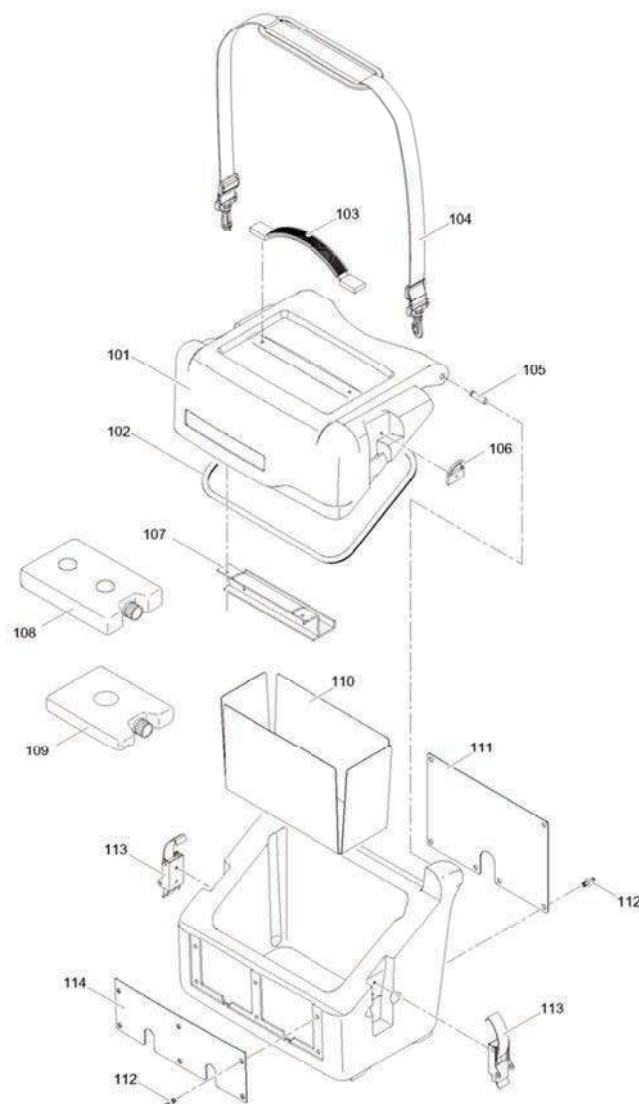

<b>Designation</b>	<b>Use</b>	<b>Example of use, transport of</b>
MT4-ET-32	Temperature of materials to be transported $-32^{\circ}\text{C}$	Fresh frozen plasma (FFP)
MT4-ET+4	Temperature of materials to be transported $+4^{\circ}\text{C}$	Erythrocyte concentrates (EC)
MT4-ET+22	Temperature of materials to be transported $+22^{\circ}\text{C}$	Thrombocyte concentrates (TC)
MT4-ET+37	Temperature of materials to be transported $+37^{\circ}\text{C}$	Warm blood samples



Thanks to the use of eutectic thermal energy storage elements, the range of use can be significantly extended. Here, specially adapted thermal energy stores in two sizes can now be used for different temperature ranges. The nominal volumes are 600 ml and 300 ml.

The range of use specified in each case reflects the desired transport temperature. The thermal energy stores must be charged before every transport task. The thermal energy is stored within the phase transition process. During the liquid – solid transition (melting and freezing), thermal energy is released or absorbed.

The thermal energy stores are filled with a paraffin-based phase transition material.

Storage element	Photograph
ET-32 (Range of use -32 °C)	
ET+4 (Range of use +4 °C)	
ET+22 (Range of use +22 °C)	
ET+37 (Range of use +37 °C)	

## Acceptance criteria

The stipulations of the European Commission published in

### **Guide to the preparation, use and quality assurance of blood components**

European Committee (Partial Agreement) on Blood Transfusion {CD-P-TS}, European Directorate for the Quality of Medicines & HealthCare (EDQM)

15th Edition 2009 (published April 2010)

and the recognised state of the art in science and technology serve as acceptance criteria for the evaluation of the measurement results for this validation.

Specifically, this defines the following temperature limits:

#### 1. Whole blood for the preparation of blood components (WB)

"Whole blood for preparation of blood components may be kept up to 24 hours in conditions validated to maintain temperature between +20°C and +24°C, which is prerequisite for the production of platelet preparations from whole blood."

*Chapter 5, Part A, Paragraph 1, 4. Storage and Transport*

#### 2. Erythrocyte concentrates (EC)

"Red Cells [BCR/AS/BCR-AS/LD/LD-AS/Aph] must be kept at a controlled temperature between +2°C to +6°C [...]. Validated transport systems must ensure that at no time during a maximum transit time of 24 hours did the temperature exceed +10°C."

*Chapter 5, Part B, Paragraph 1-7, 4. Storage and Transport*

#### 3. Thrombocyte concentrates (TC)

"Storage temperature must be +20°C to +24°C under constant agitation.[...] During transportation the temperature of Platelets [Rec, SU/Rec, Pool/Rec, Pool, LD/Rec, Pool, AS/Rec, Pool, LD-AS/Aph/Aph, LD/Aph, AS/Aph, LD-AS] must be kept as close as possible to recommended storage temperature[...]."

*Chapter 5, Part C, Paragraph 1-9, 4. Storage and Transport*

#### 4. Fresh frozen plasma (FFP)

"Plasma, fresh frozen [Cryoprecipitate/Plasma, Fresh Frozen, Cryoprecipitate-Depleted] [...]. The following storage times and temperatures are permitted [Approved storage times are]:

36 months at below -25°C; 3 months at -15°C to -25°C. Storage temperature must be maintained during transport."

*Chapter 5, Part D, Paragraph 1-3, 4. Storage and Transport*

#### 5. Blood samples for checking cold agglutinins (BSCA)

Temperatures of about +30°C to +36°C for the transport of blood samples for checking cold agglutinins have proven to be effective in practice for ensuring the results of analysis. There are no unambiguous standard specifications. Dedicated scientific research on this topic has not been published to date.

## Measuring methodology

The transport systems including the discharge plates were stored at room temperature (+18 °C to +22 °C) until loading. The eutectic thermal energy stores were preconditioned for over 24 hours at the specified temperature of use in accordance with the manufacturer's instructions. Here a distance of about 1.5 cm was maintained between the individual elements.

The measurements were taken with autonomous dataloggers in the closed transport containers so that there was no adverse effect caused by the measurement wires to be fed into the containers and monitoring of practical value could be conducted. Like the transport containers and the discharge plates, the datalogger had also been stored at room temperature beforehand.

The material to be transported to be represented was substituted by dummies. Commercially available blood, plasma and thrombocyte bags from the firm of Fresenius and Monovettes from the firm of Sarstedt were used here. The contents consisted in each case of a 0.9% solution of sodium chloride in water (isotonic table salt solution, infusion solution, also physiological salt solution). It is comparable with human blood in terms of the boiling and freezing points and also isoosmotic with blood plasma.

Original preparation	Dummy designation	Bag system	Filling volume
Whole blood (WB)	VB-D	Fresenius Kabi™ Composelect® 4x bag system	500-600 ml Ø 550 ml
Erythrocyte concentrate (EC)	EK-D	Fresenius Kabi™ Composelect®	250-310 ml Ø 280 ml
Thrombocyte concentrate (TC)	TK-D	Caridian BCr™ platelet bag	220-340 ml Ø 270 ml
Fresh frozen plasma (FFP)	GFP-D	Haemonetics™ component bag with individual cardboard packaging	200-300 ml Ø 250 ml
EDTA blood samples	MonoV-D	Sarstedt™ EDTA Monovette 9 ml	8-10 ml Ø 9 ml

In the measurements of the minimum load status, the temperature changes shown were recorded directly on the dummy material to be transported (centred in two dimensions). In the measurements of the typical and maximum load statuses, the temperature changes shown were recorded directly between the dummy material to be transported (centred in three dimensions).

## Summary of results, abbreviated

Configuration	Ambient Temperature	Load	Hold-Over Time
Dometic MT4-ET-32	-10.0°C	2xGFP-D	> 24 h.
Dometic MT4-ET-32	+22.0°C	2xGFP-D	12:33 h:min
Dometic MT4-ET-32	+43.0°C	2xGFP-D	5:30 h:min
Dometic MT4-ET+4	-10.0°C	1xEK-D	9:27 h:min
Dometic MT4-ET+4	-10.0°C	8xEK-D	11:18 h:min
Dometic MT4-ET+4	+22.0°C	1xEK-D	15:42 h:min
Dometic MT4-ET+4	+22.0°C	8xEK-D	18:36 h:min
Dometic MT4-ET+4	+43.0°C	1xEK-D	6:33 h:min
Dometic MT4-ET+4	+43.0°C	8xEK-D	7:33 h:min
Dometic MT4-ET+22	-10.0°C	2xTK-D	2:33 h:min
Dometic MT4-ET+22	+43.0°C	2xTK-D	4:09 h:min
Dometic MT4-ET+37	-10.0°C	10xMonoV-D	2:08 h:min
Dometic MT4-ET+37	+22.0°C	10xMonoV-D	15:02 h:min
Dometic MT4-ET+37	+43.0°C	10xMonoV-D	0:46 h:min





**MT4-ET-32, ambient temperature -10°C, Load 2xGFP-D**



**MT4-ET-32, ambient temperature -10°C, Dummy temperature -40°C**  
**Load 2xGFP-D, 1x600ml ET-32, 4x300ml ET-32**

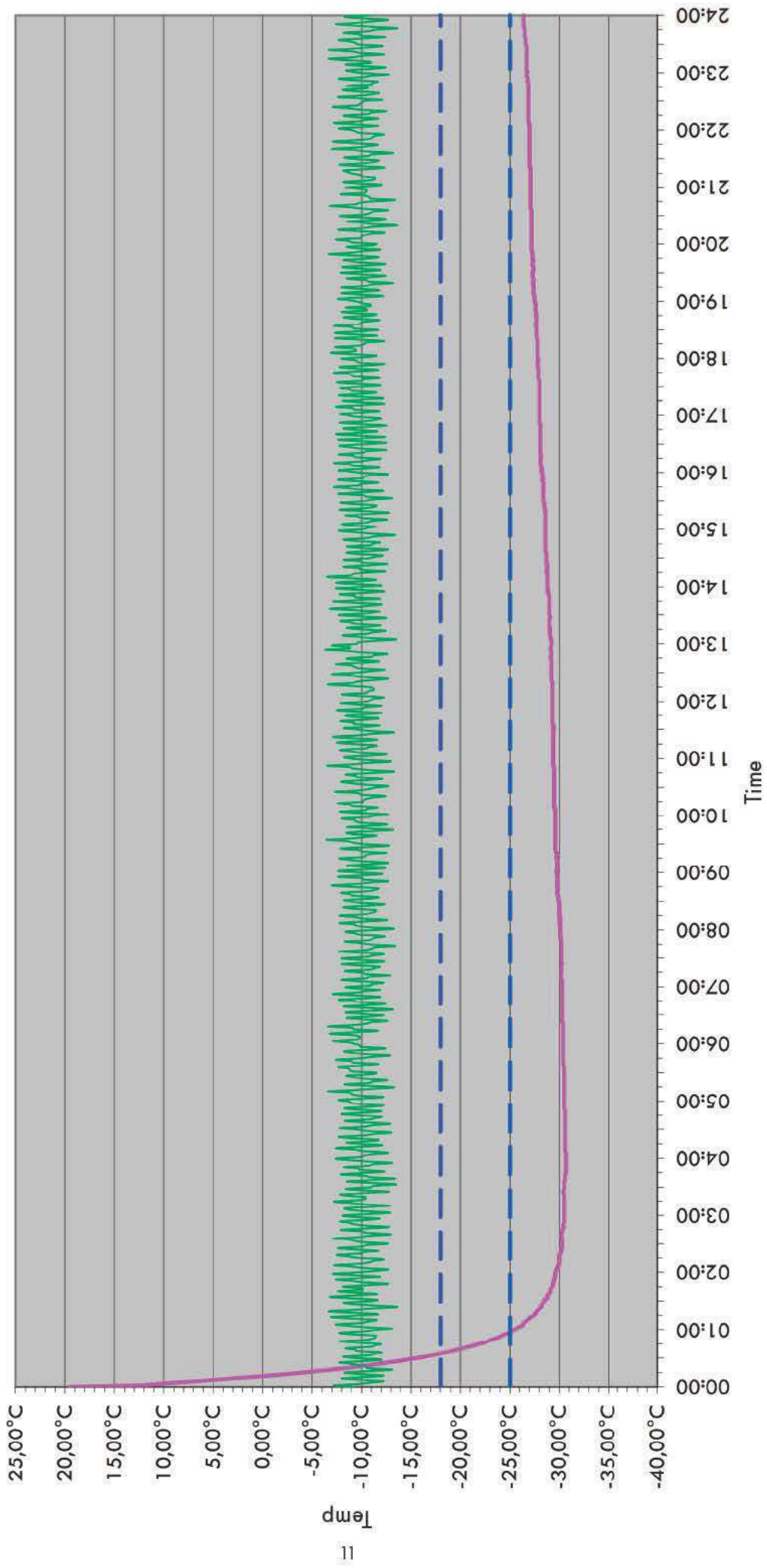

**MT4-ET-32, ambient temperature +22°C, Load 2xGFP-D**



**MT4-ET-32, ambient temperature +22°C, Dummy temperature -40°C  
Load 2xGFP-D, 1x600ml ET-32, 4x300ml ET-32**

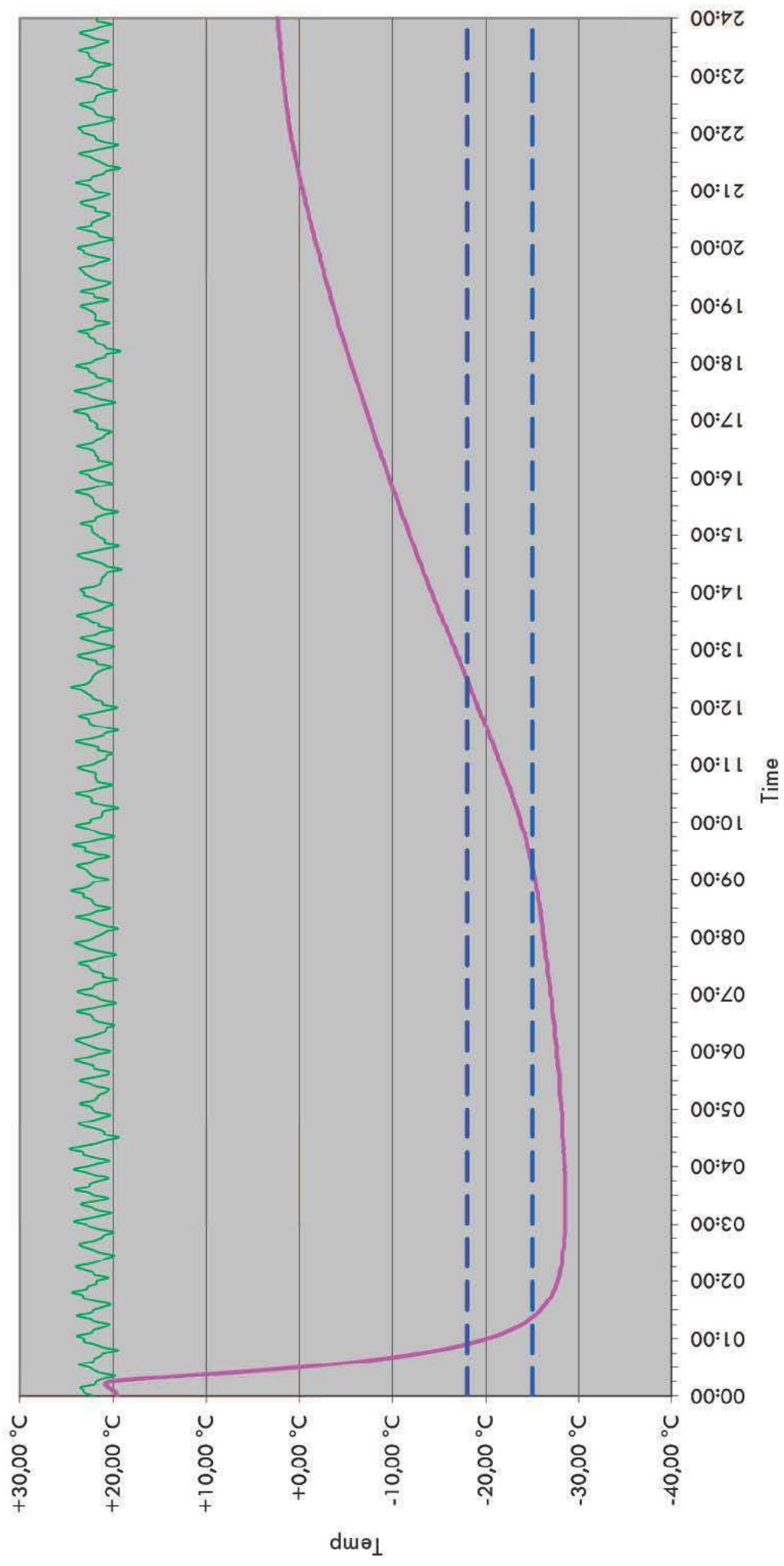

**MT4-ET-32, ambient temperature +43°C, Load 2xGFP-D**



**MT4-ET-32, ambient temperature +43°C, Dummy temperature -40°C  
Load 2xGFP-D, 1x600ml ET-32, 4x300ml ET-32**

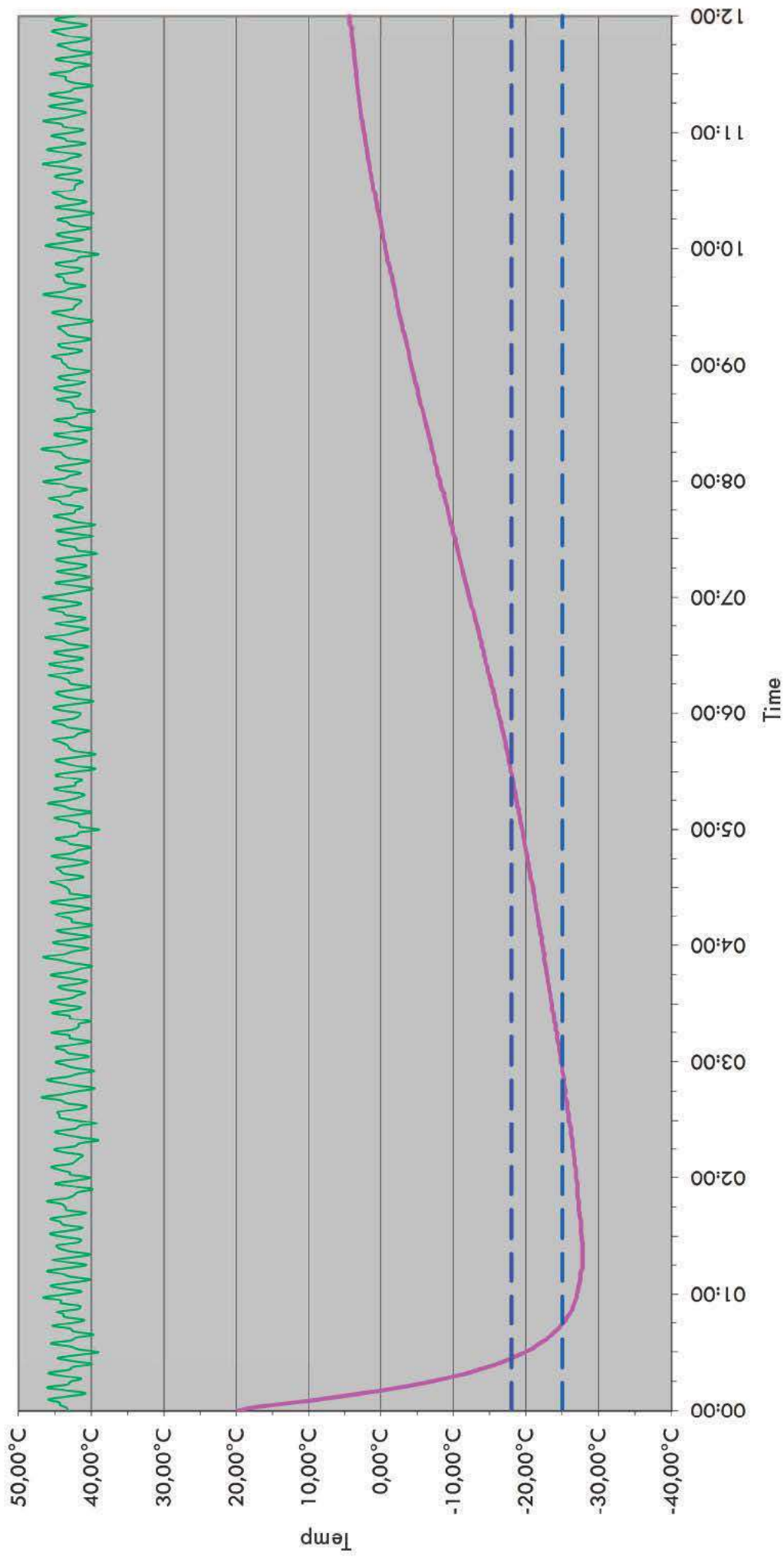

**MT4-ET+4, ambient temperature -10°C, Load 1xEK-D**





**MT4-ET+4, ambient temperature -10°C, Dummy temperature +4°C  
Load 1xEK-D, 1x600ml ET+4, 4x300ml ET+4**

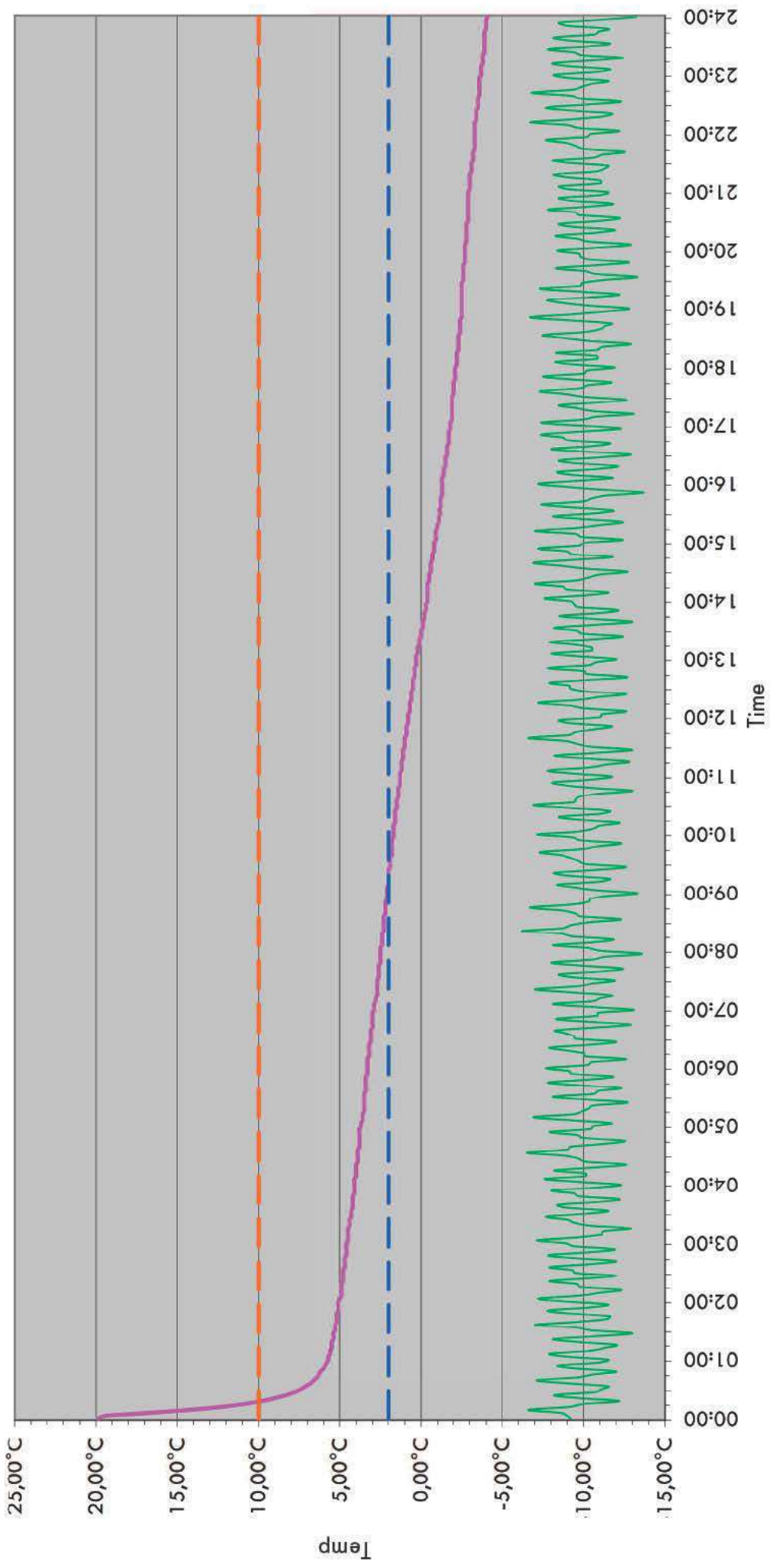

**MT4-ET+4, ambient temperature -10°C, Load 8xEK-D**



**MT4-ET+4, ambient temperature -10°C, Dummy temperature +4°C**

**Load 8xEK-D, 1x600ml ET+4, 4x300ml ET+4**

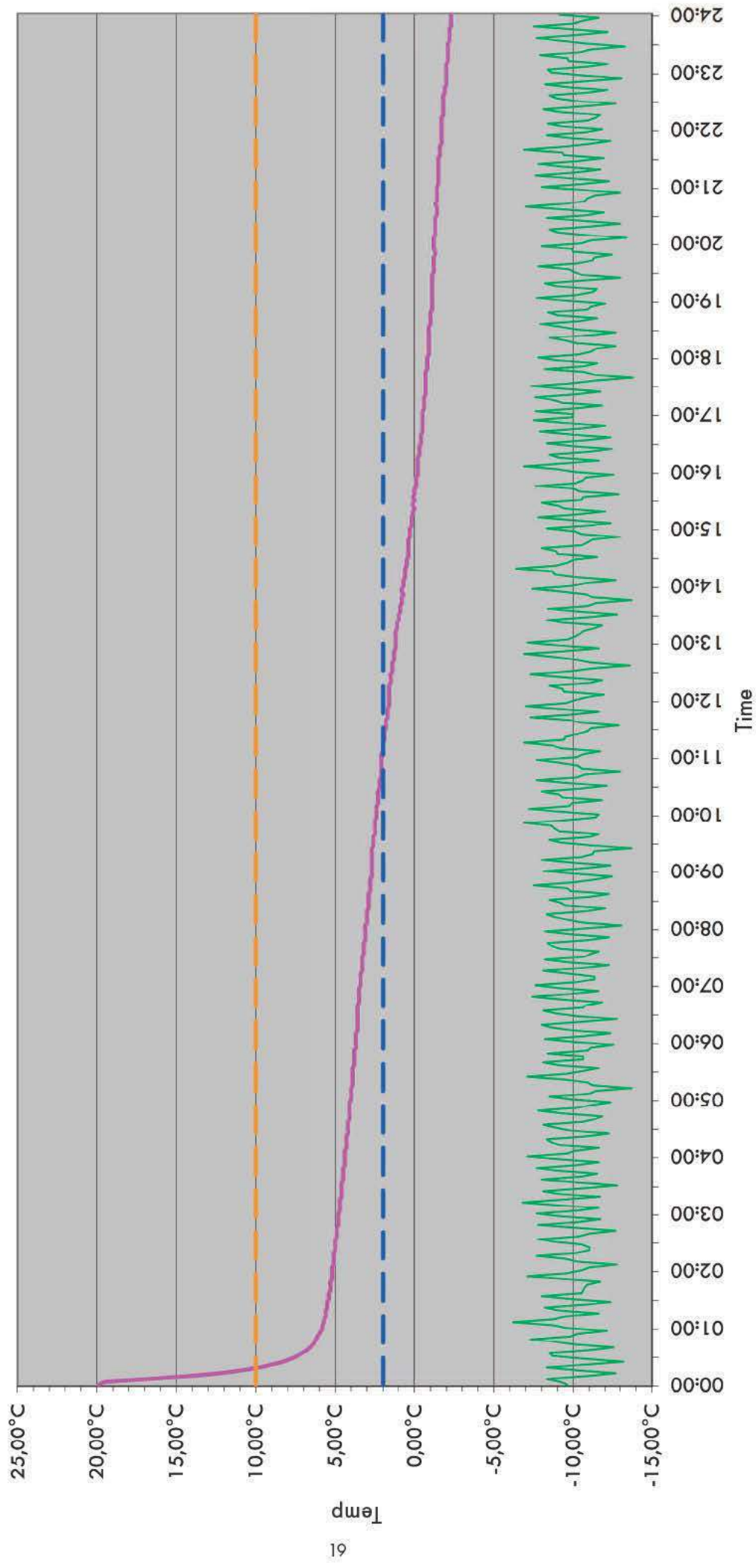

**MT4-ET+4, ambient temperature +22°C, Load 1xEK-D**



**MT4-ET+4, ambient temperature +22°C, Dummy temperature +4°C**  
**Load 1xEK-D, 1x600ml ET+4, 4x300ml ET+4**

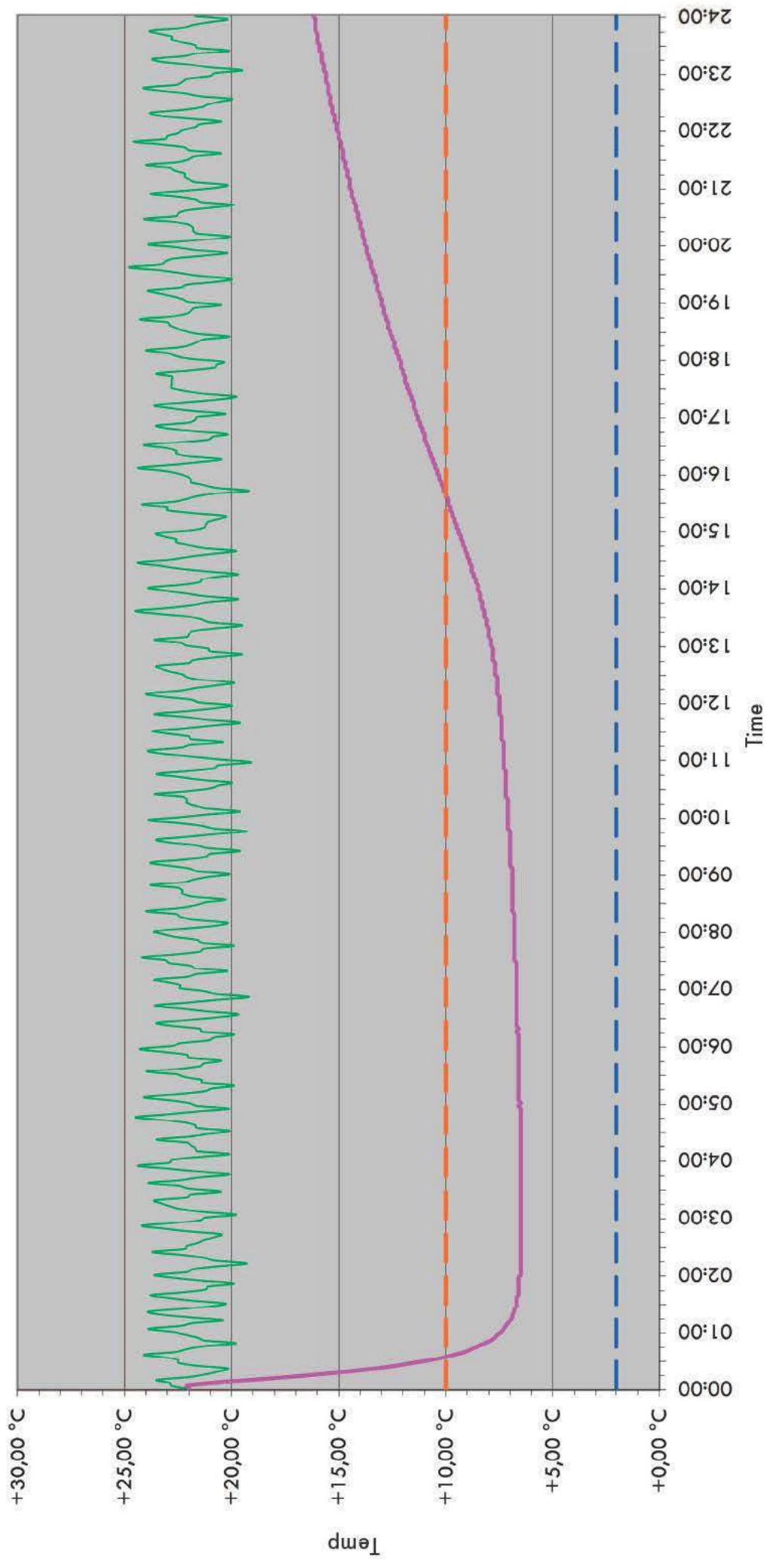

**MT4-ET+4, ambient temperature +22°C, Load 8xEK-D**



**MT4-ET+4, ambient temperature +22°C, Dummy temperature +4°C**  
**Load 8xEK-D, 1x600ml ET+4, 4x300ml ET+4**

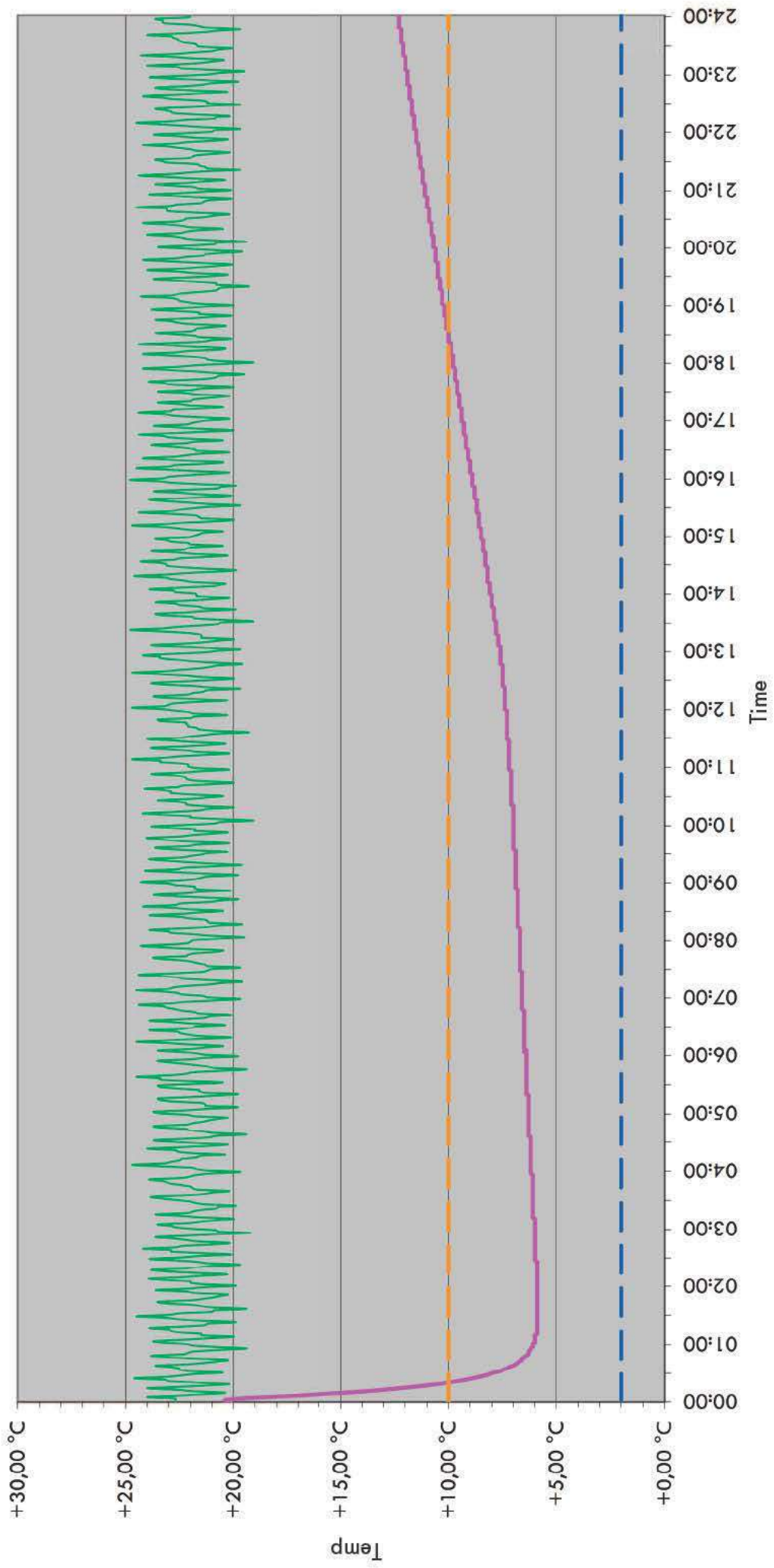

**MT4-ET+4, ambient temperature +43°C, Load 1xEK-D**





**MT4-ET+4, ambient temperature +43°C, Dummy temperature +4°C  
Load 1 xEK-D, 1x600ml ET+4, 4x300ml ET+4**

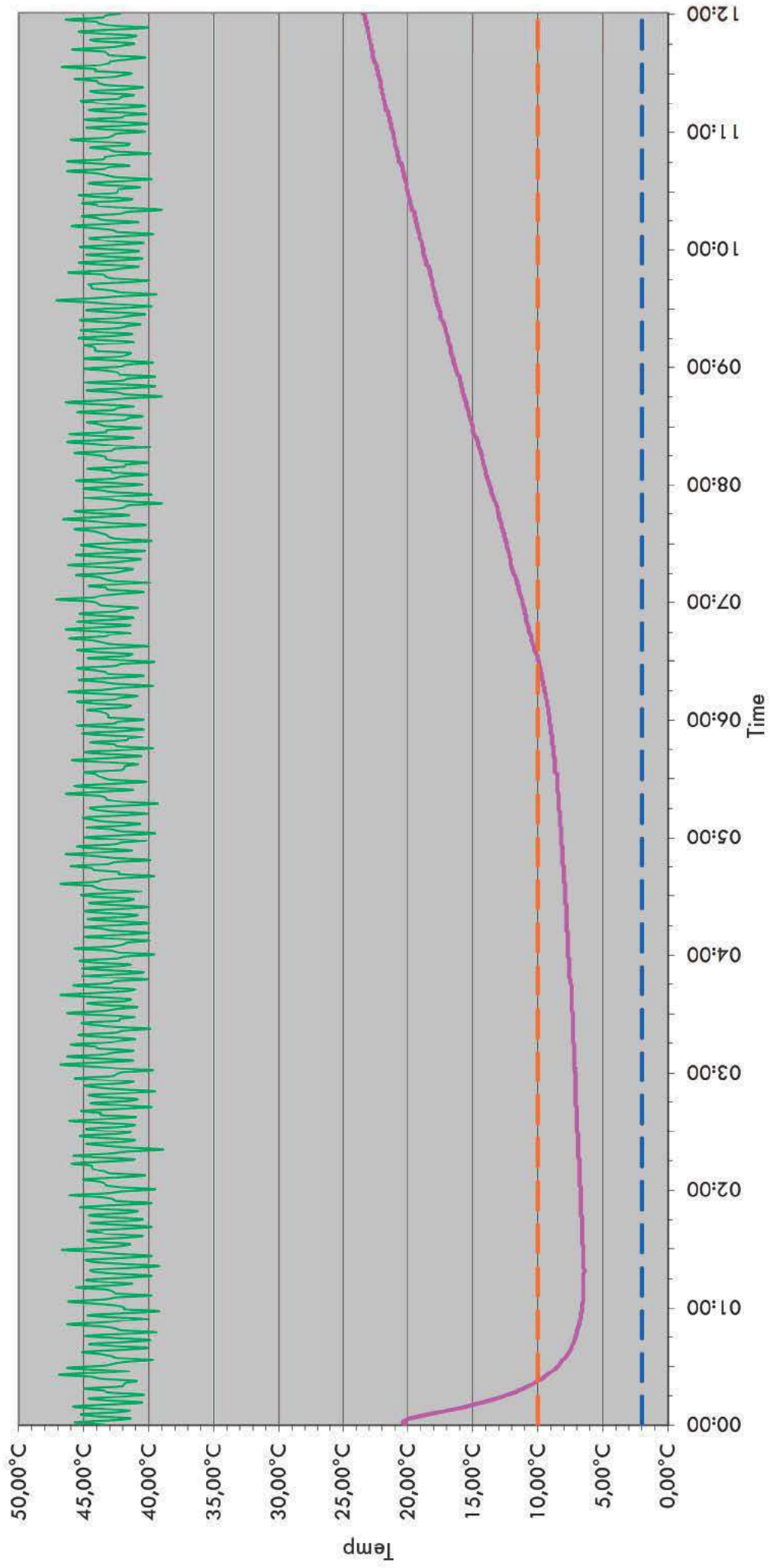

**MT4-ET-32, ambient temperature -10°C, Load 8xEK-D**



**MT4-ET+4, ambient temperature +43°C, Dummy temperature +4°C  
Load 8xEK-D, 1x600ml ET+4, 4x300ml ET+4**

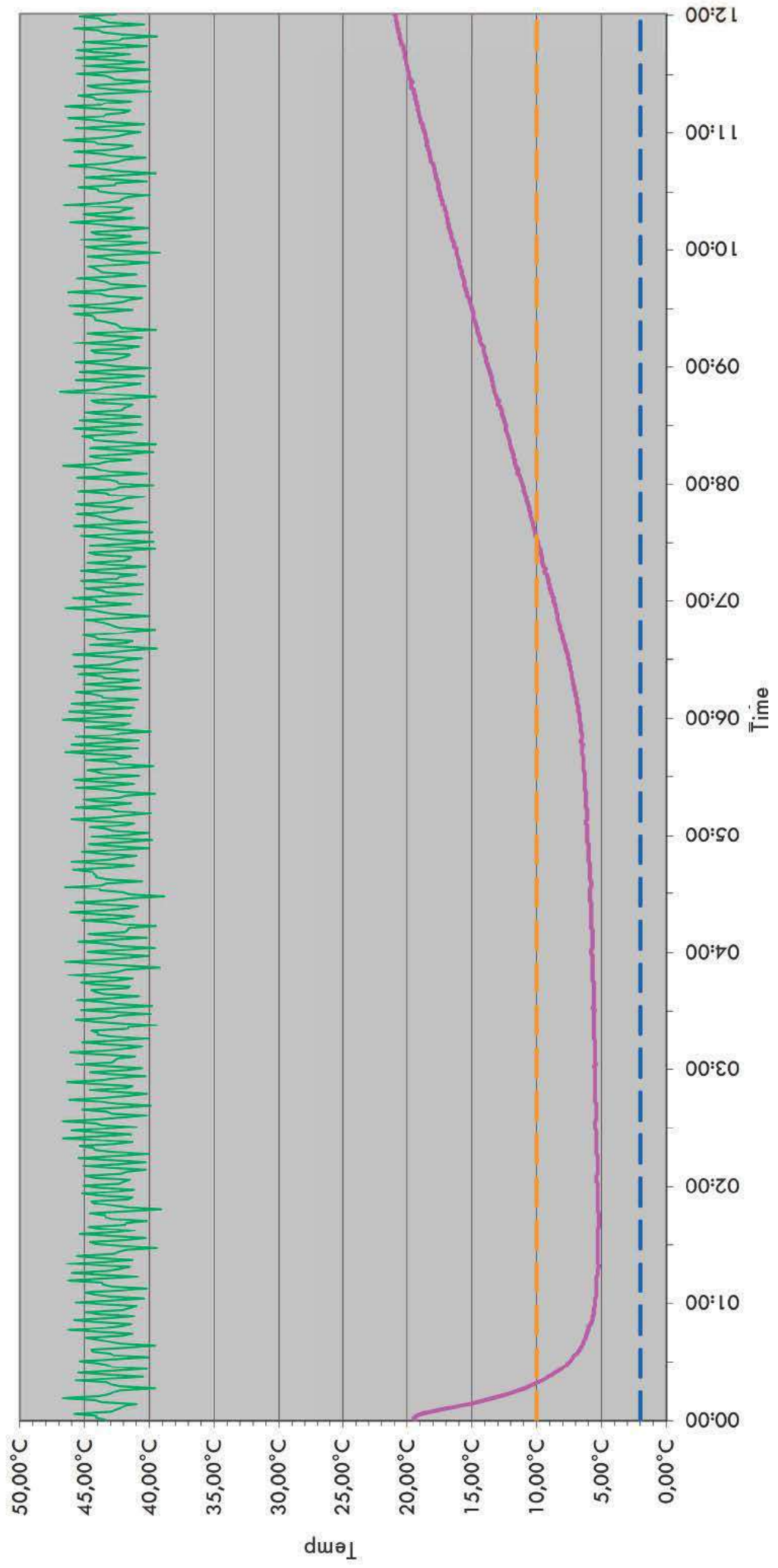

**MT4-ET+22, ambient temperature -10°C, Load 2xTK-D**



**MT4-ET+22, ambient temperature -10°C, Dummy temperature +22°C  
Load 2xTK-D, 1x600ml ET+22, 4x300ml ET+22**

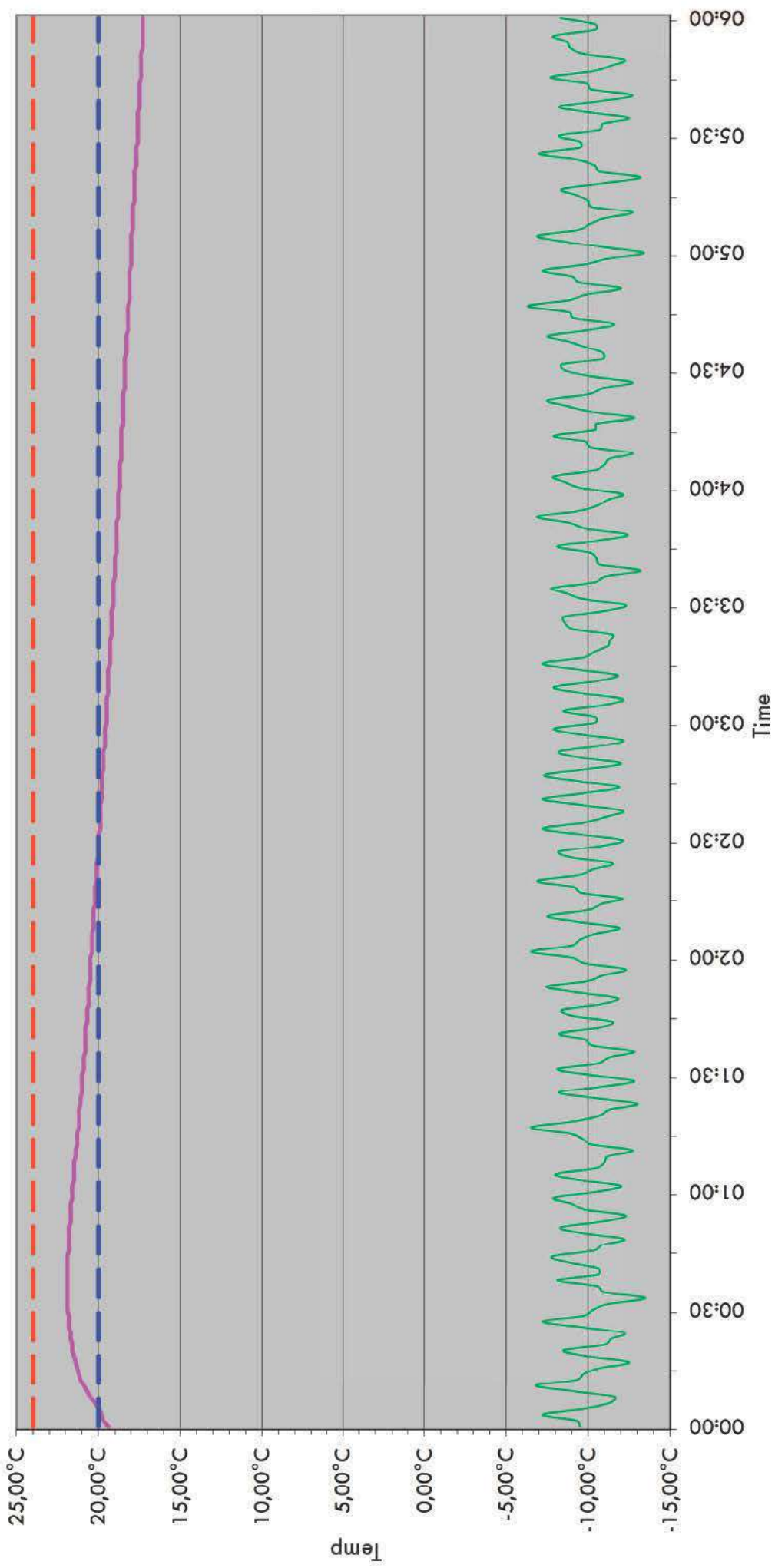

**MT4-ET+22, ambient temperature +43°C, Load 2xTK-D**



**MT4-ET+22, ambient temperature +43°C, Dummy temperature +22°C**  
**Load 2xTK, 1 x600ml ET+22, 4x300ml ET+22**

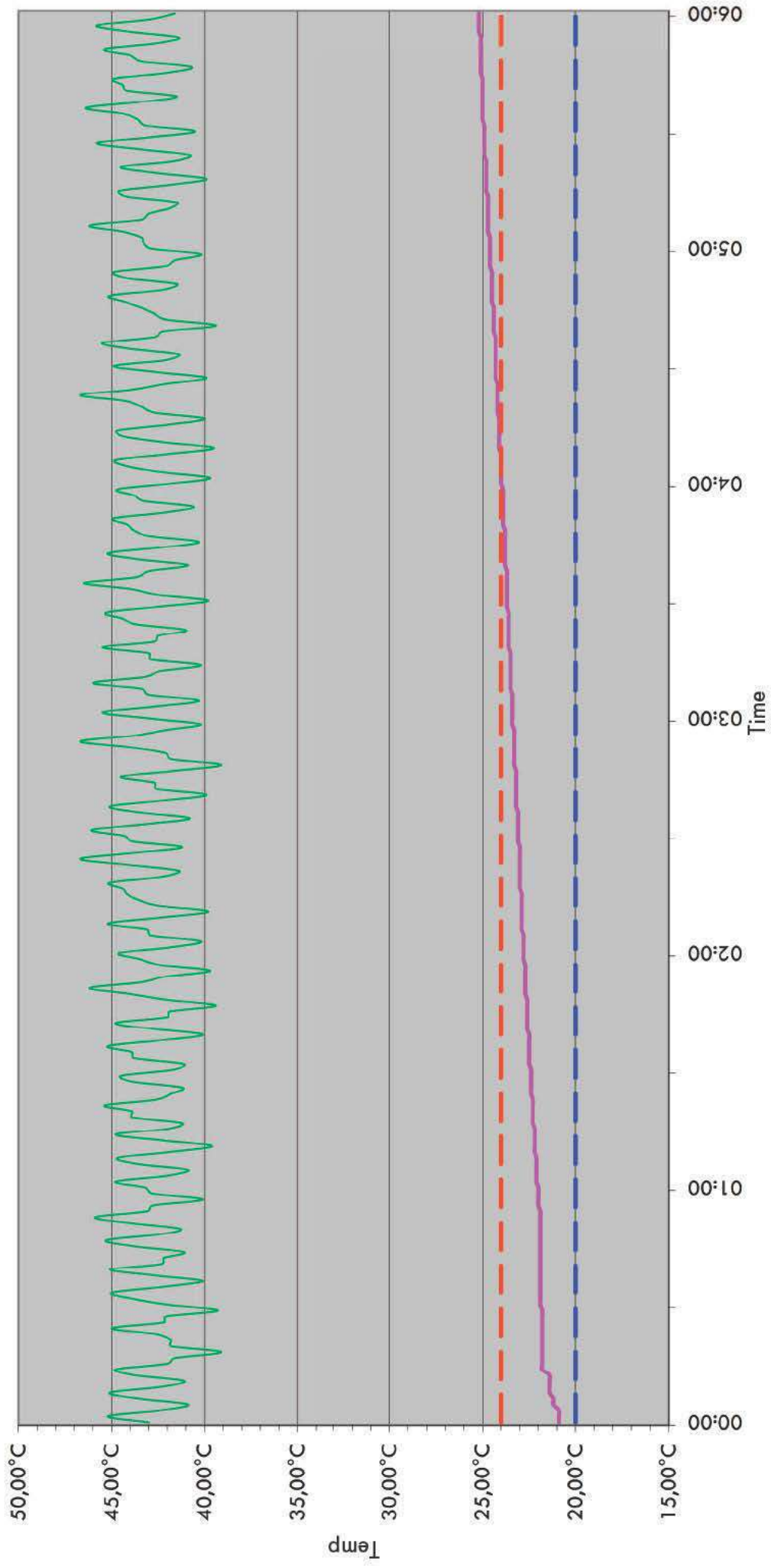

**MT4-ET+37, ambient temperature -10°C, Load 10xMonoV-D**





**MT4-ET+37, ambient temperature -10°C, Dummy temperature +36°C  
Load 10xMonoV-D, 1x600ml ET+37, 4x300ml ET+37**

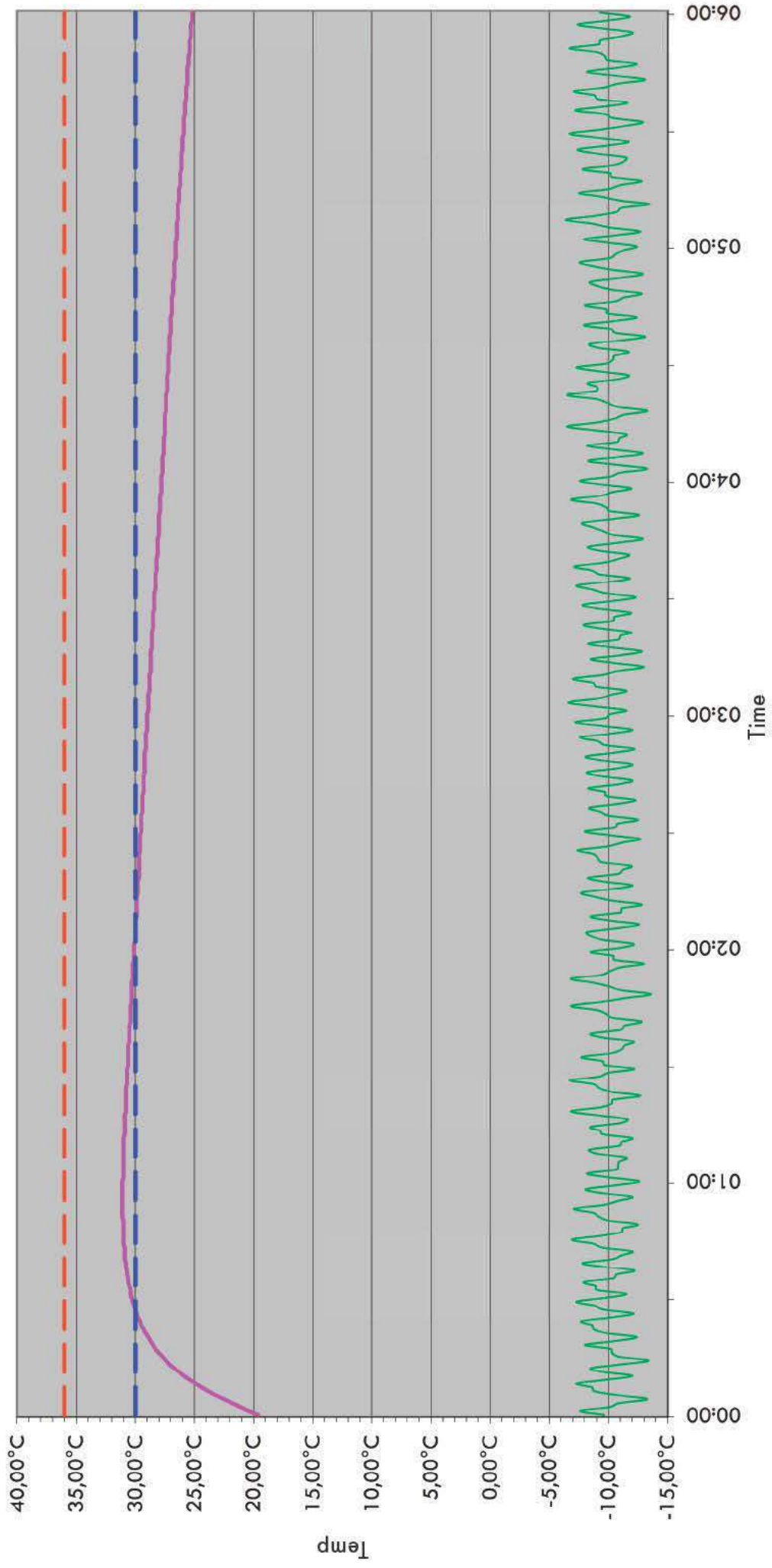

**MT4-ET+37, ambient temperature +22°C, Load 10xMonoV-D**



**MT4-ET+37, ambient temperature +22°C, Dummy temperature +36°C**  
**Load 10xMonoV-D, 1x600ml ET+37, 4x300ml ET+37**

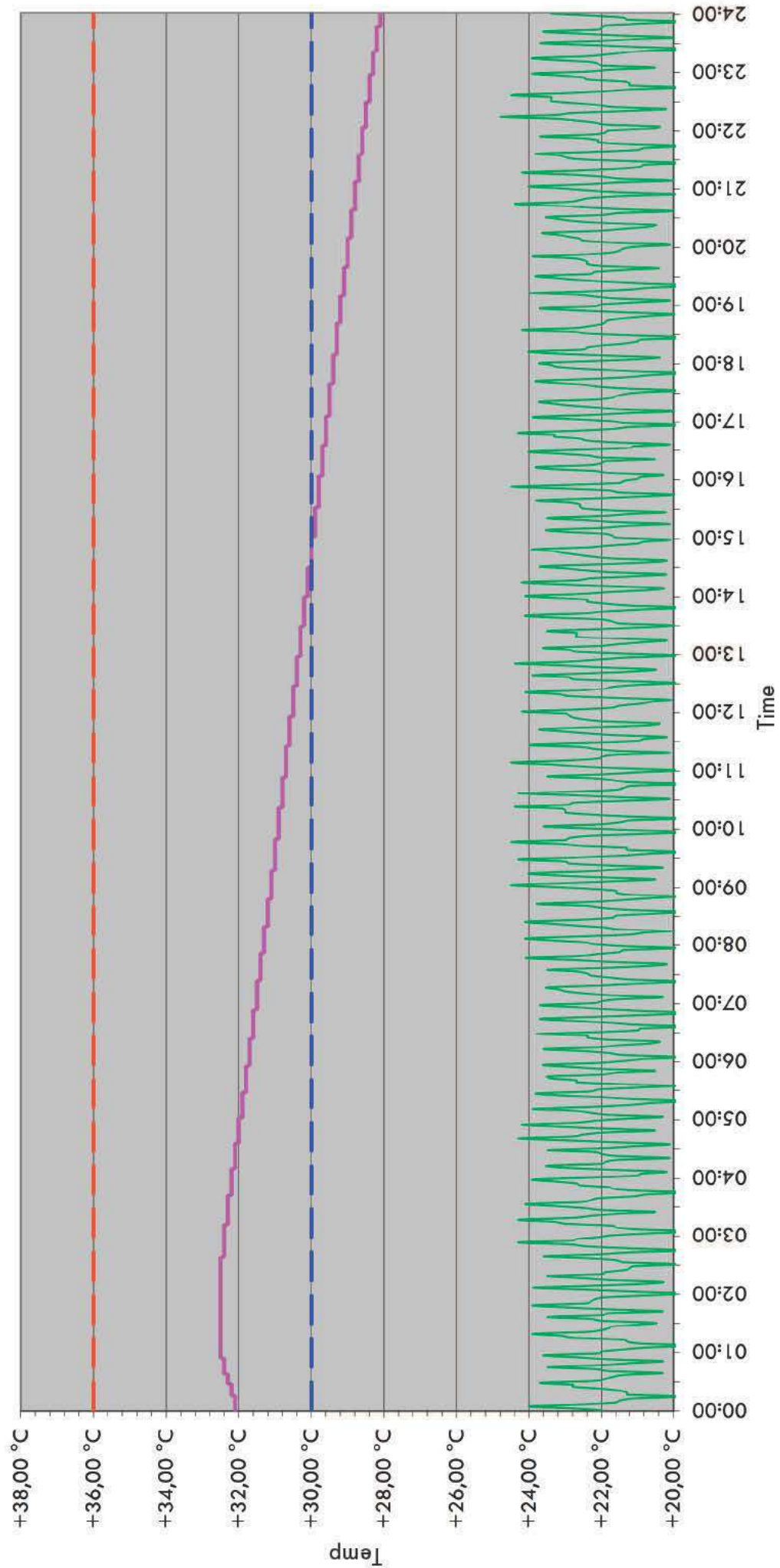

**MT4-ET+37, ambient temperature +43°C, Load 10xMonoV-D**

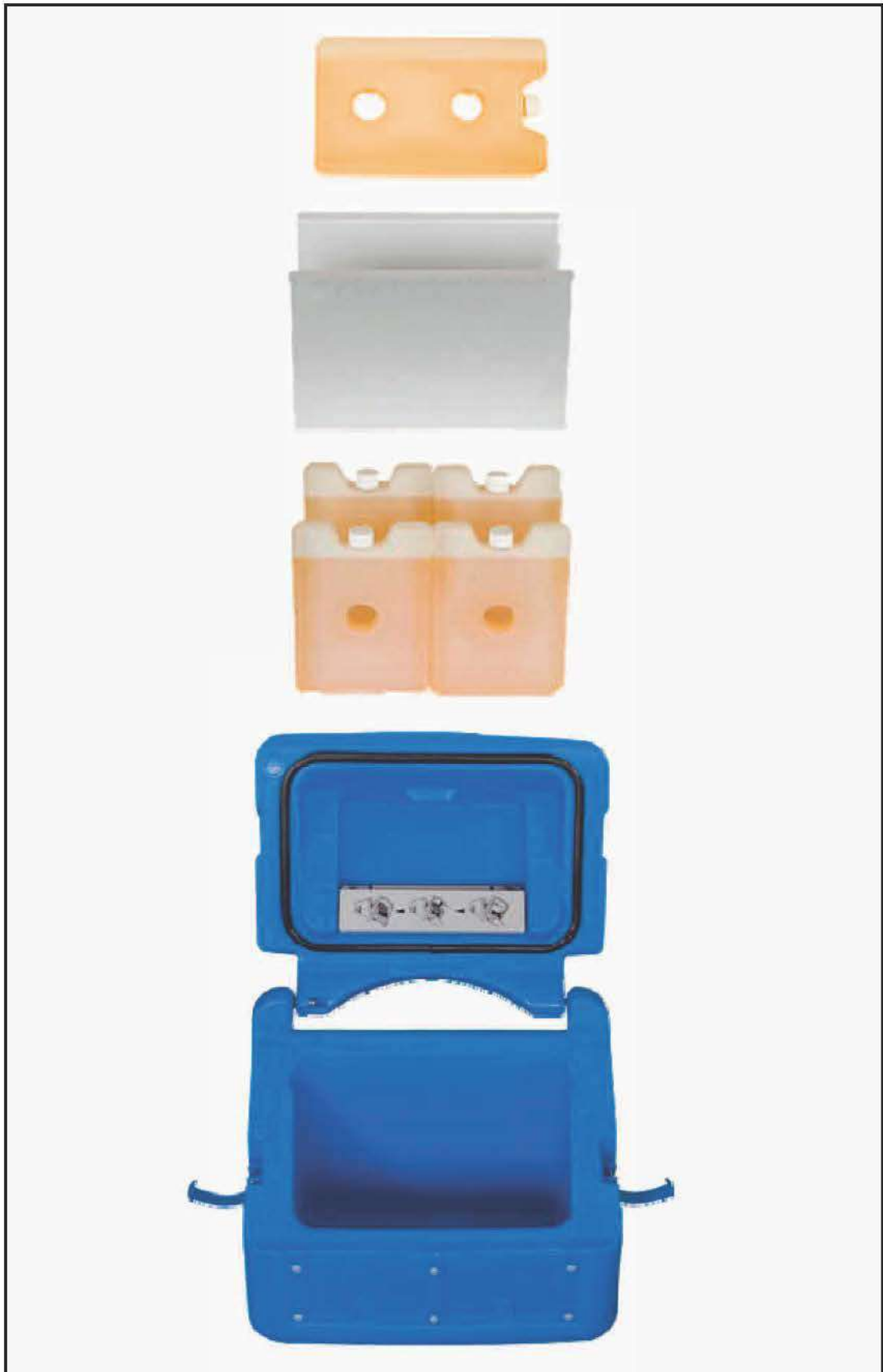

**MT4-ET+37, ambient temperature +43°C, Dummy temperature +37°C  
Load 10xMonoV-D, 1x600ml ET+37, 4x300ml ET+37**

